









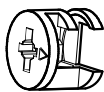
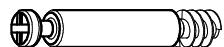

 Ø6,3x50 mm <b>A1 x 48</b>	 Ø12 mm <b>A2 x 48</b>	 4 mm <b>A3 x 1</b>	 Ø15x12 mm <b>B1 x 14</b>	 Ø5x44 mm <b>B2 x 14</b>
 Ø20 mm <b>B3 x 14</b>	 Ø12x3 mm <b>C x 4</b>	 Ø4x16 mm <b>D1 x 64</b>	 Ø3x25 mm <b>D2 x 7</b>	 Ø4x20 mm <b>D3 x 4</b>
 Ø1,6x25 mm <b>F x 174</b>	 Ø8x36 mm <b>G x 41</b>	 <b>I x 4</b>	 <b>K x 4</b>	 Ø5x16 mm <b>L x 8</b>
 <b>M x 2</b>	 <b>N x 5</b>	 422 mm <b>O1 x 1</b>	 342 mm <b>O2 x 1</b>	 <b>Z x 7</b>

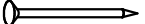
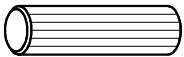
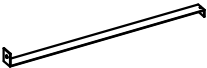
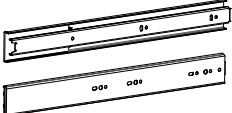

### Box 1/3

847x424x16 mm

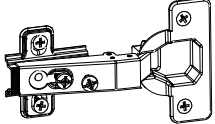
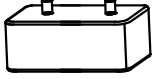
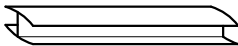
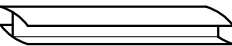

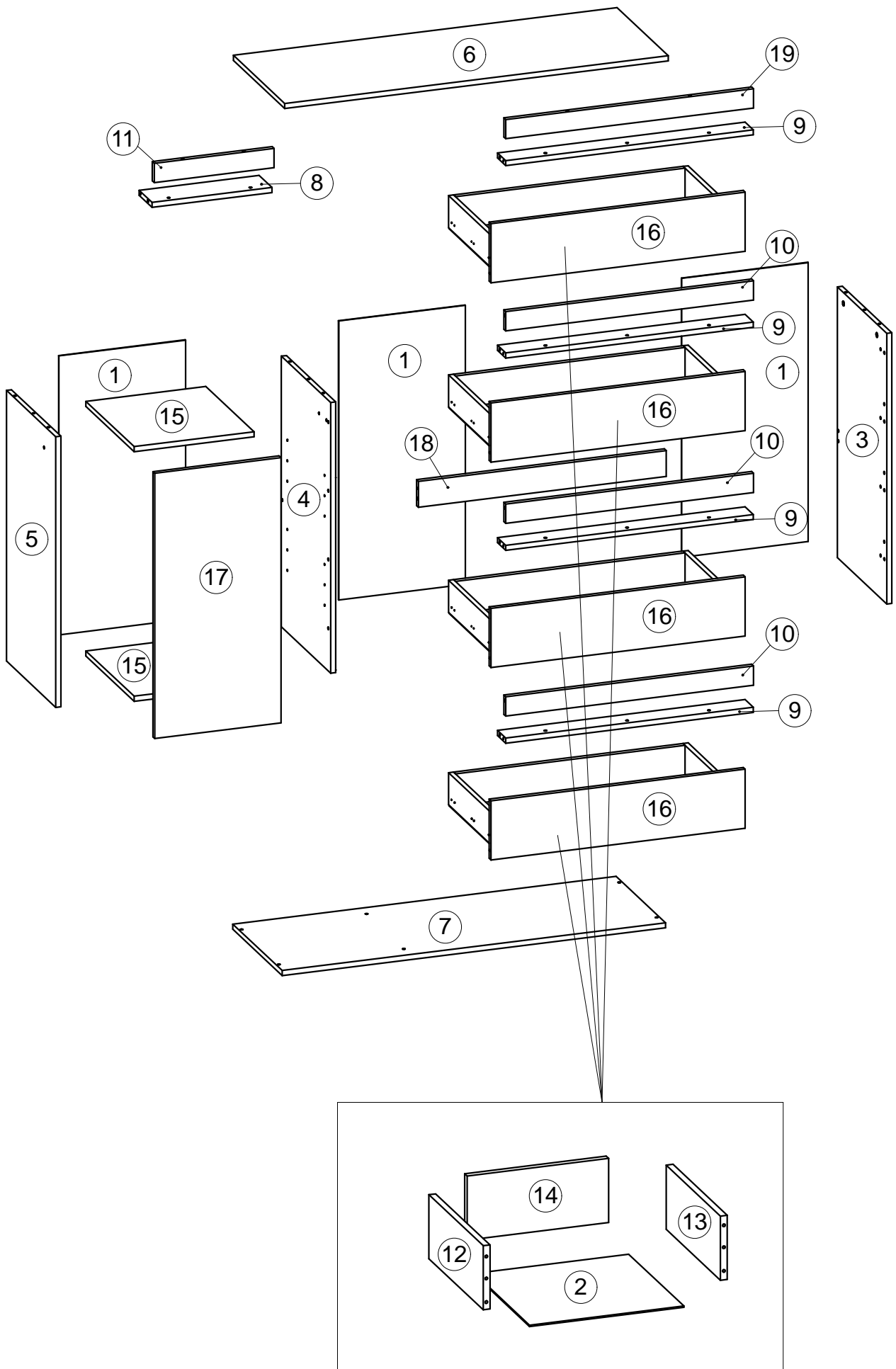
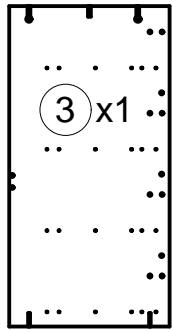
847x424x16 mm

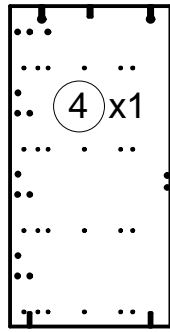

847x424x16 mm

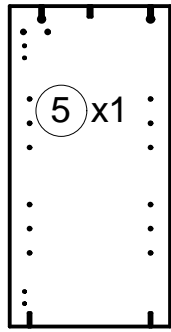

375x110x16 mm

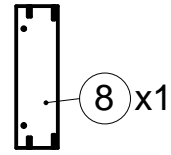

775x70x16 mm

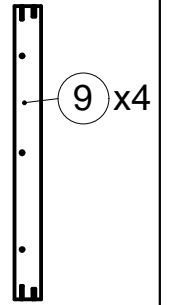

400x100x16 mm

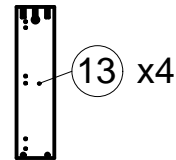

775x60x16 mm

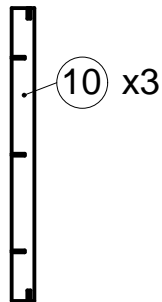

375x60x16 mm

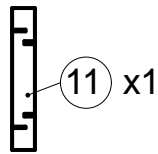

775x80x16 mm

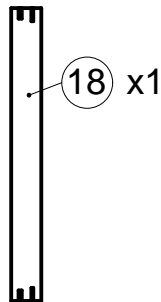

775x60x16 mm

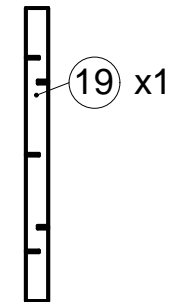

718x100x16 mm

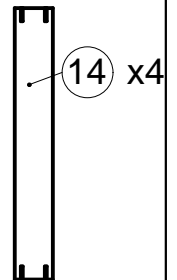

400x100x16 mm

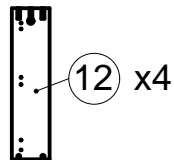

Fittings & Tools

### Box 2/3

414x375x16 mm

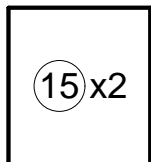

794x184x16 mm

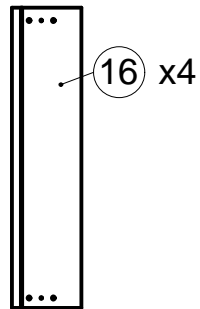

394x829x16 mm

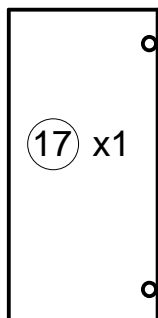

### Box 3/3

1199x440x16 mm

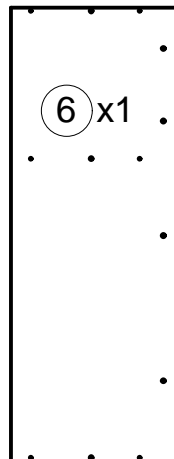

1199x424x16 mm

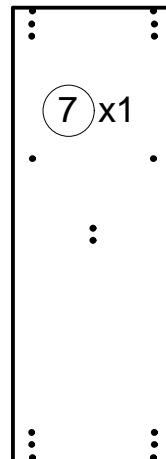

873x396x3 mm

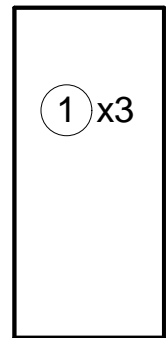

748x406x3 mm

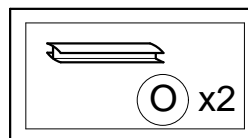
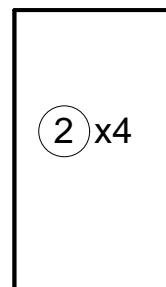

1



B1 x 2



G x 8

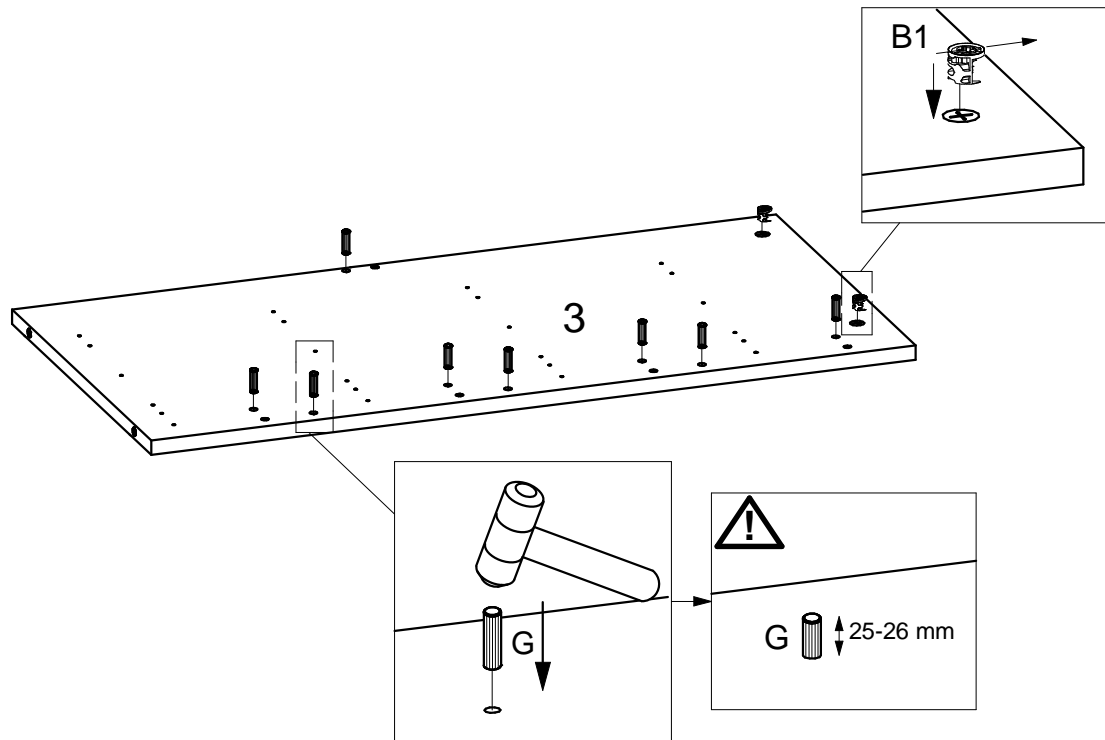
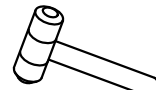
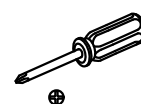

2



B1 x 2



D1 x 4



G x 1



L x 4



M.1 x 2

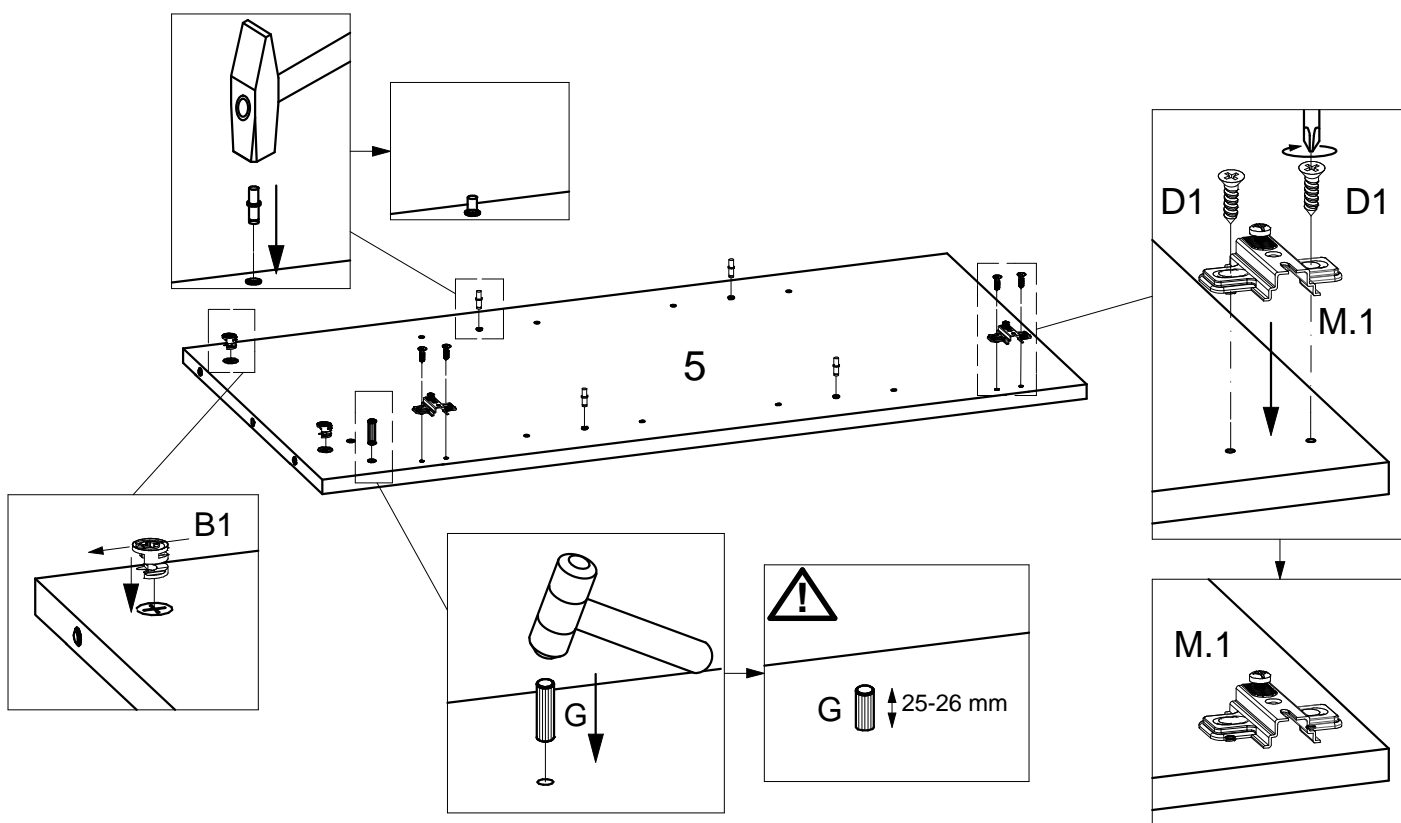
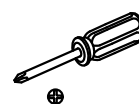
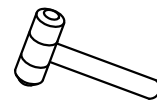
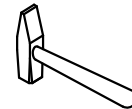

3

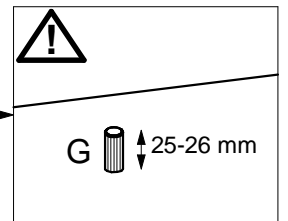
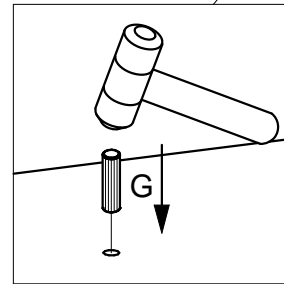
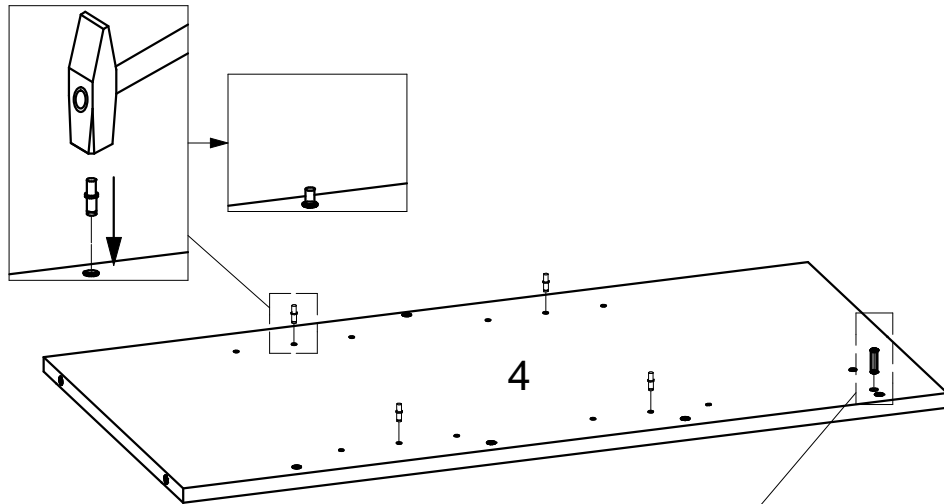
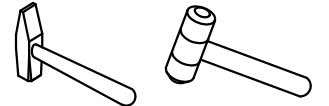
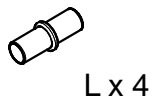
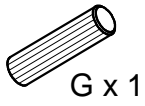

4

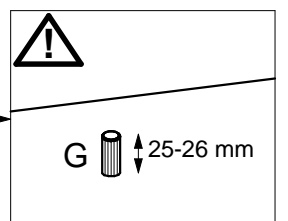
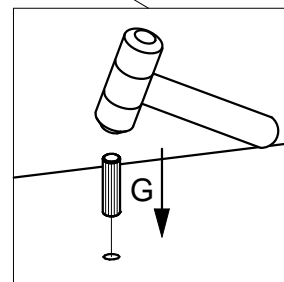
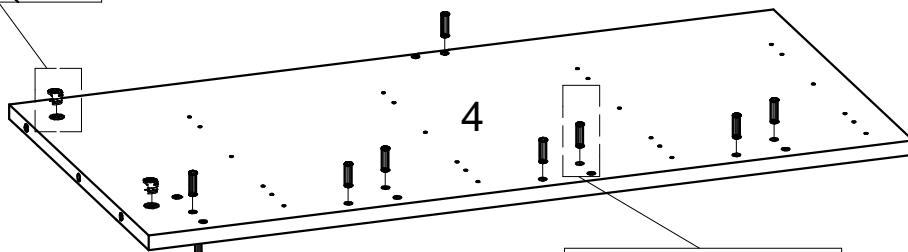
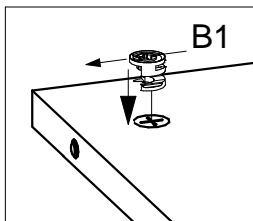
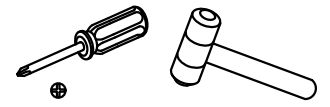
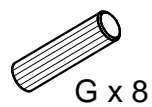
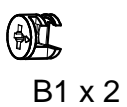

5

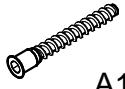

A1 x 2



A2 x 2



A3 x 1

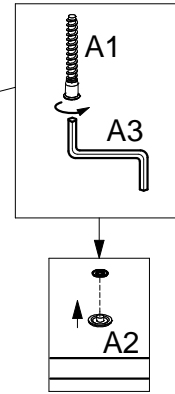
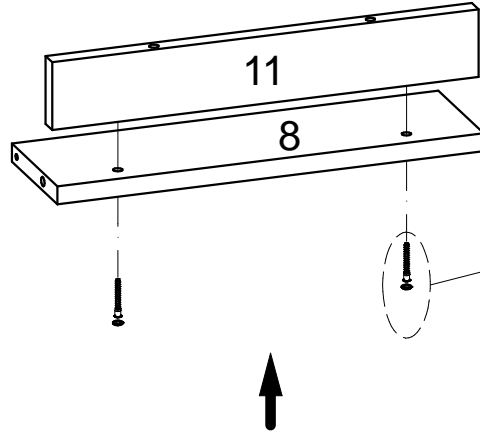

6



A1 x 3



A2 x 3



A3 x 1

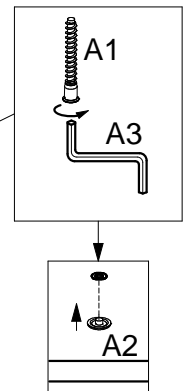
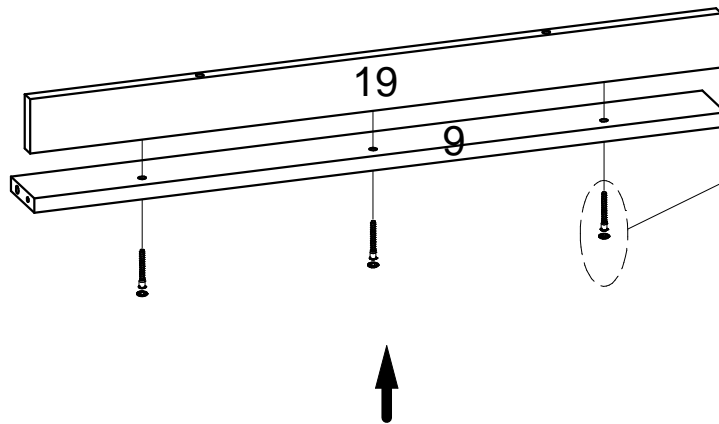



7

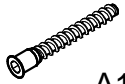

A1 x 9



A2 x 9



A3 x 1

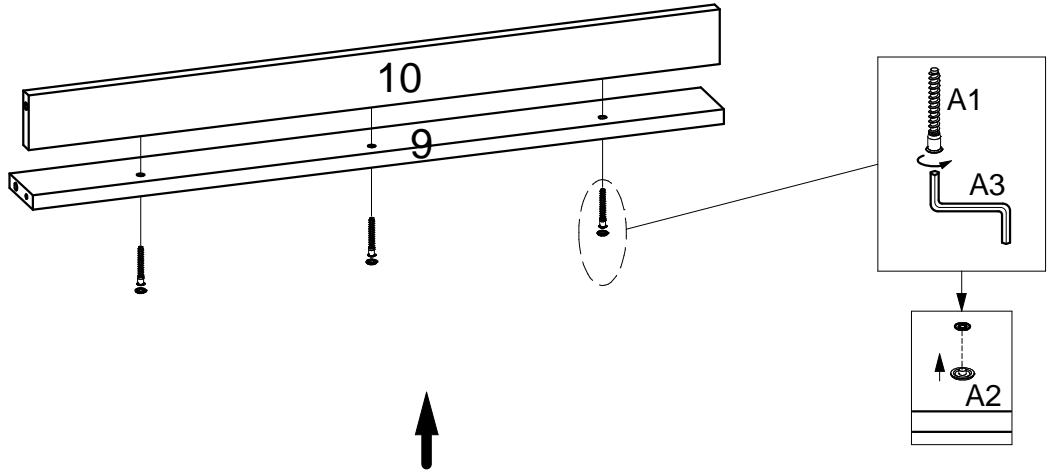

x 3

8



A1 x 10



A2 x 10



A3 x 1

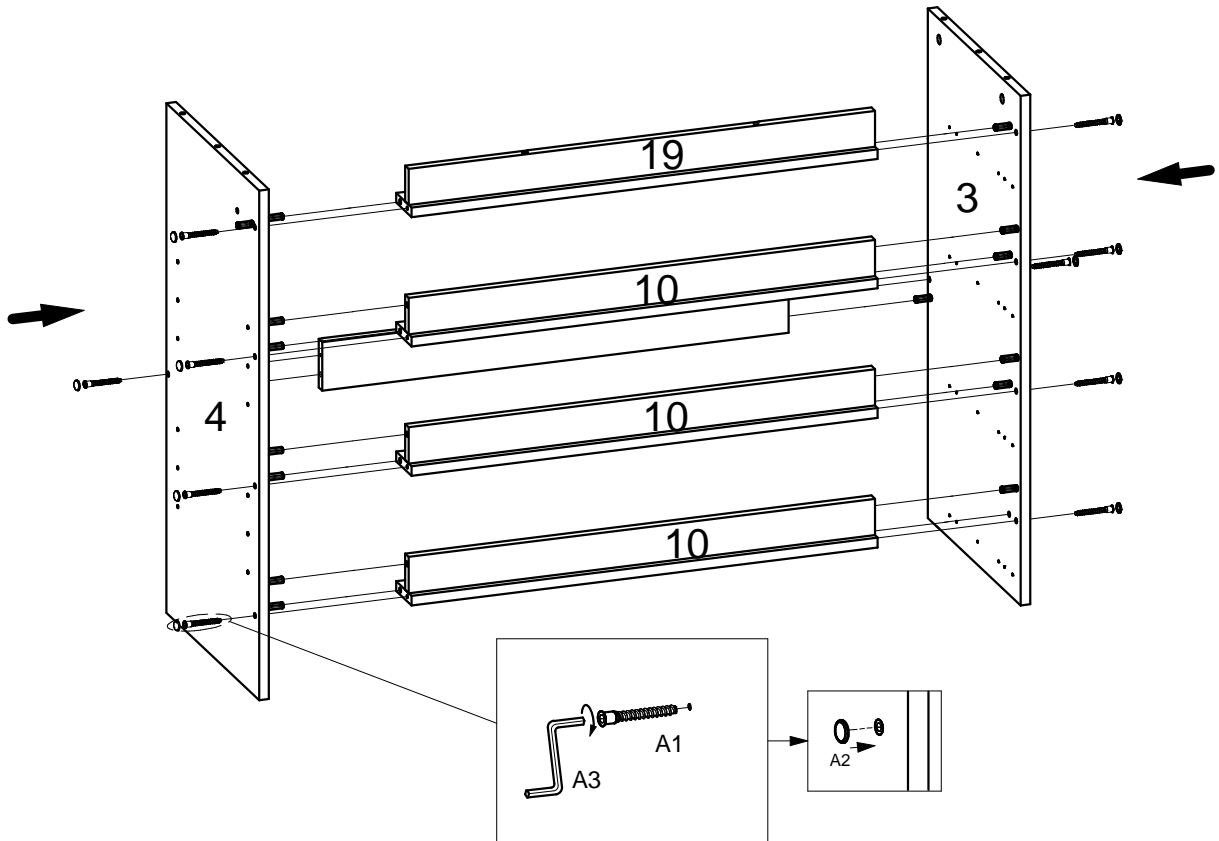
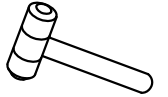

9

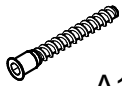

A1 x 2



A2 x 2



A3 x 1

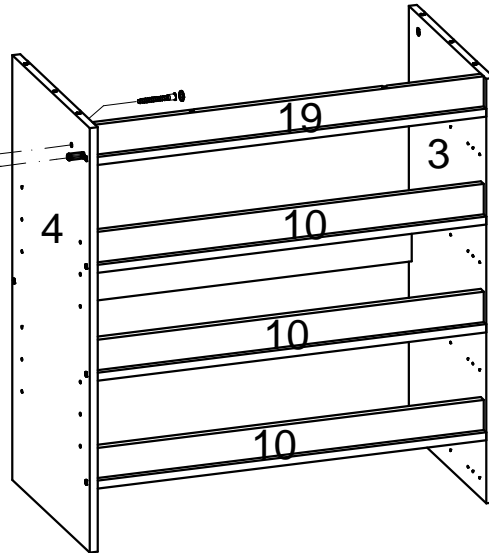
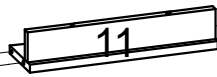
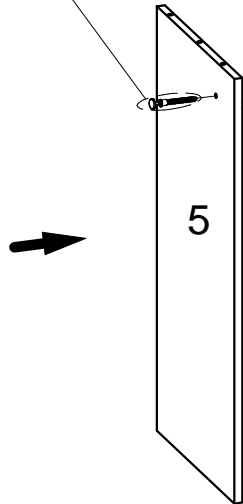
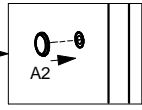
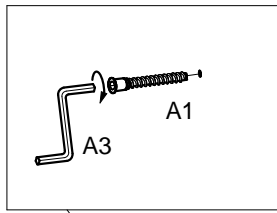
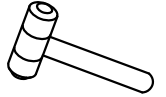

10

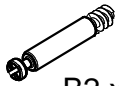

B2 x 6



G x 7

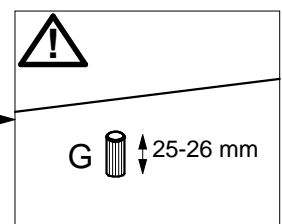
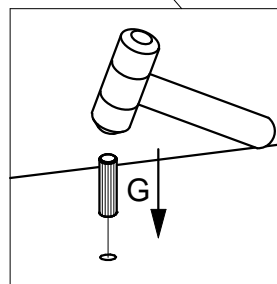
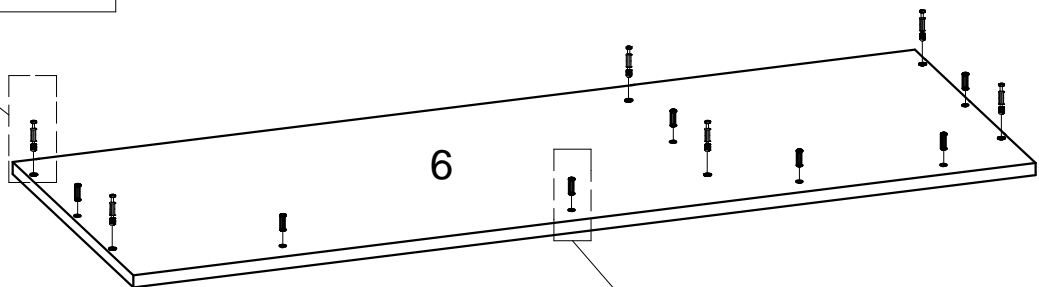
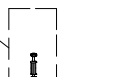
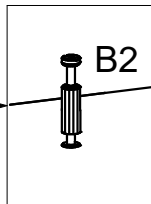
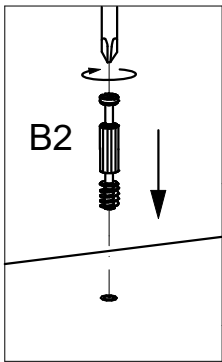
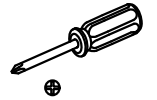
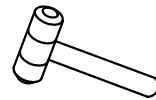

11

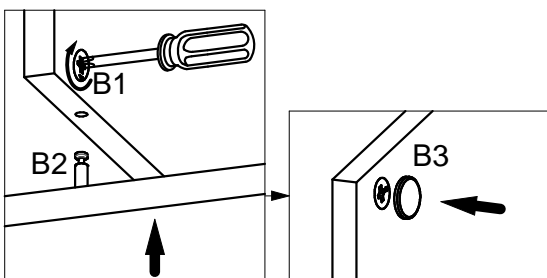
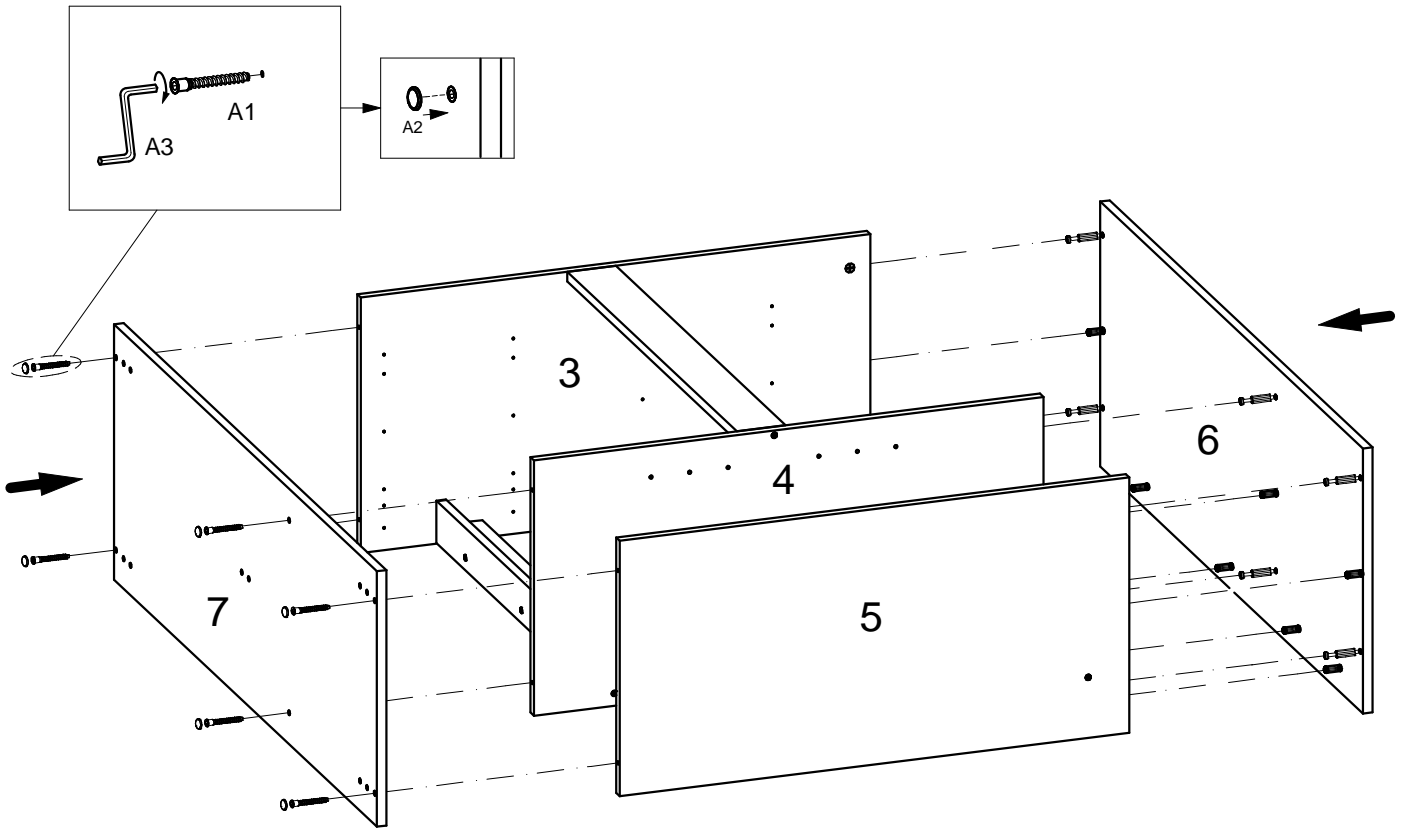
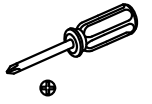
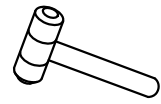
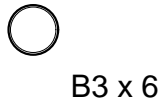
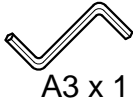
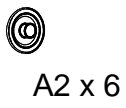
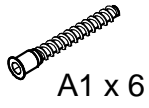

12

- C x 4
- D3 x 4
- D2 x 7
- F x 46
- N x 5
- Z x 7
- O1 x 1
- O2 x 1

⚠ XX=YY≅90°

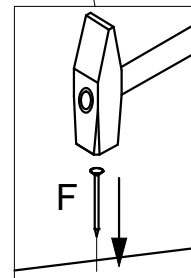
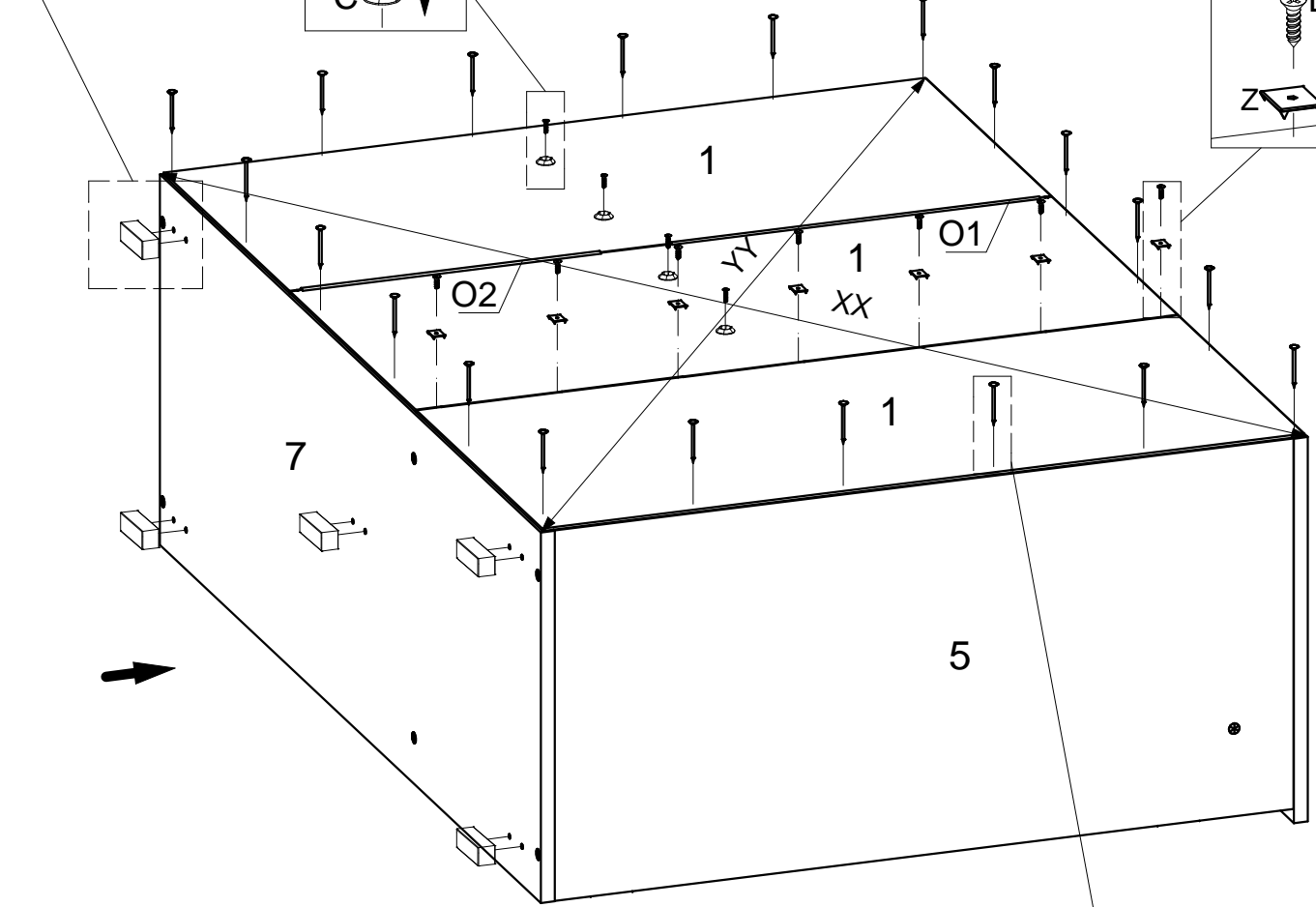
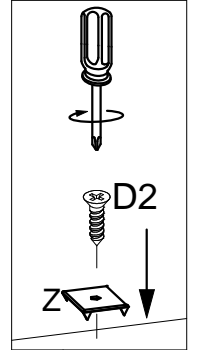
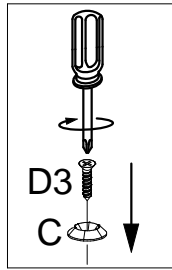
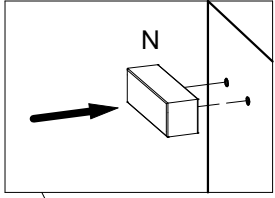
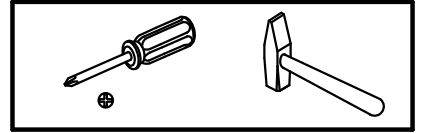

13



D1 x 24

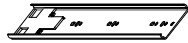

K.1 x 4



K.2 x 4

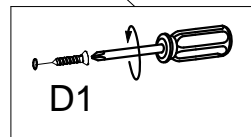
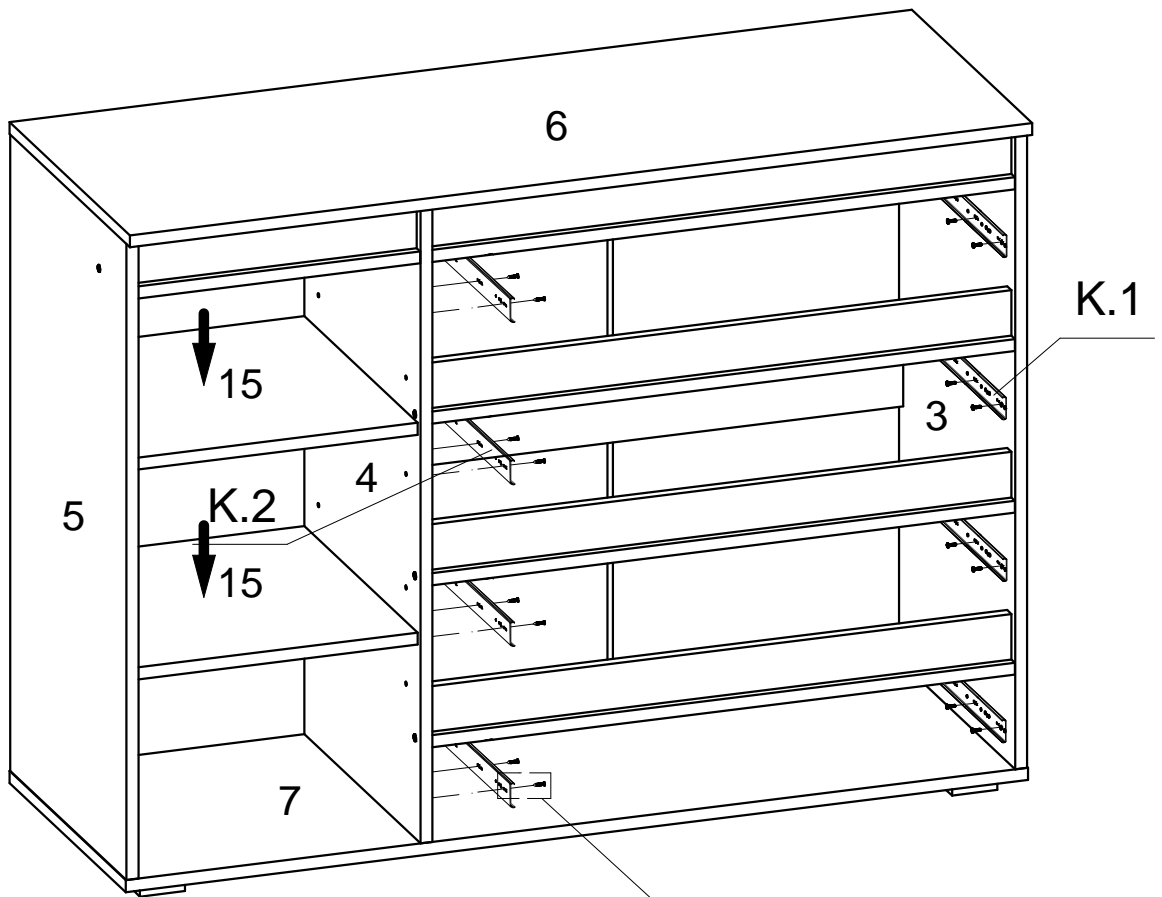
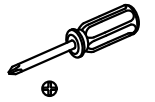

14

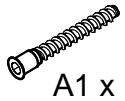

A1 x 16



A2 x 16



A3 x 1



B1 x 8

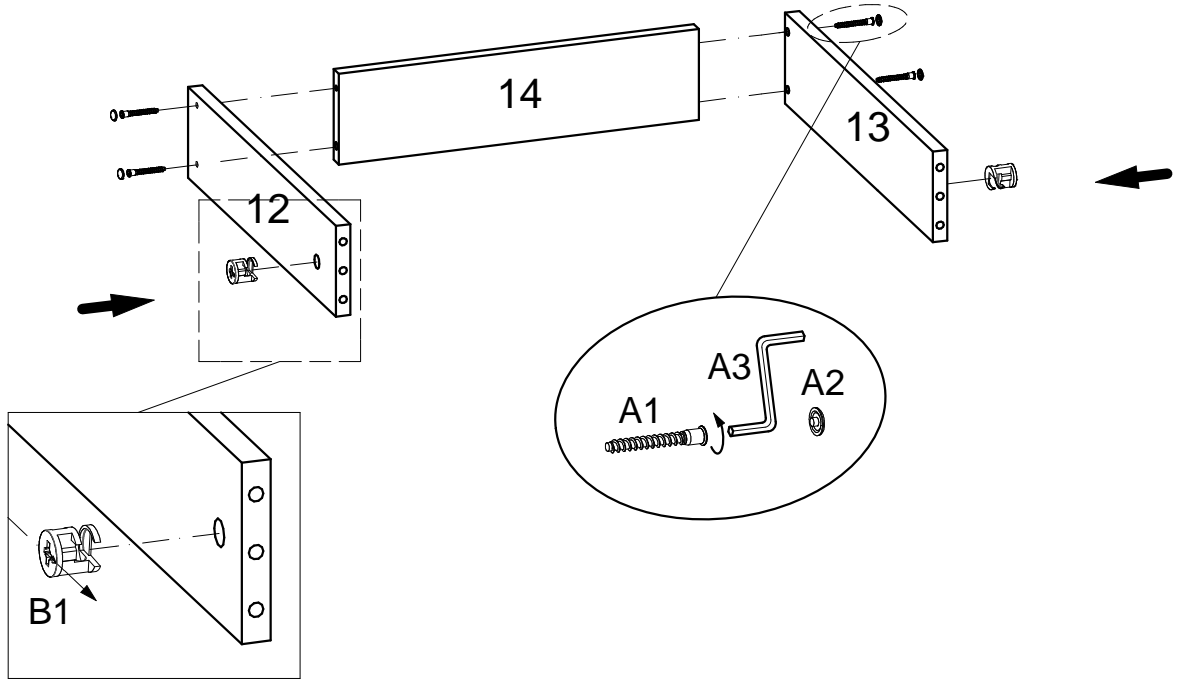

x 4

15

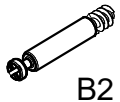

B2 x 8



B3 x 8



G x 16

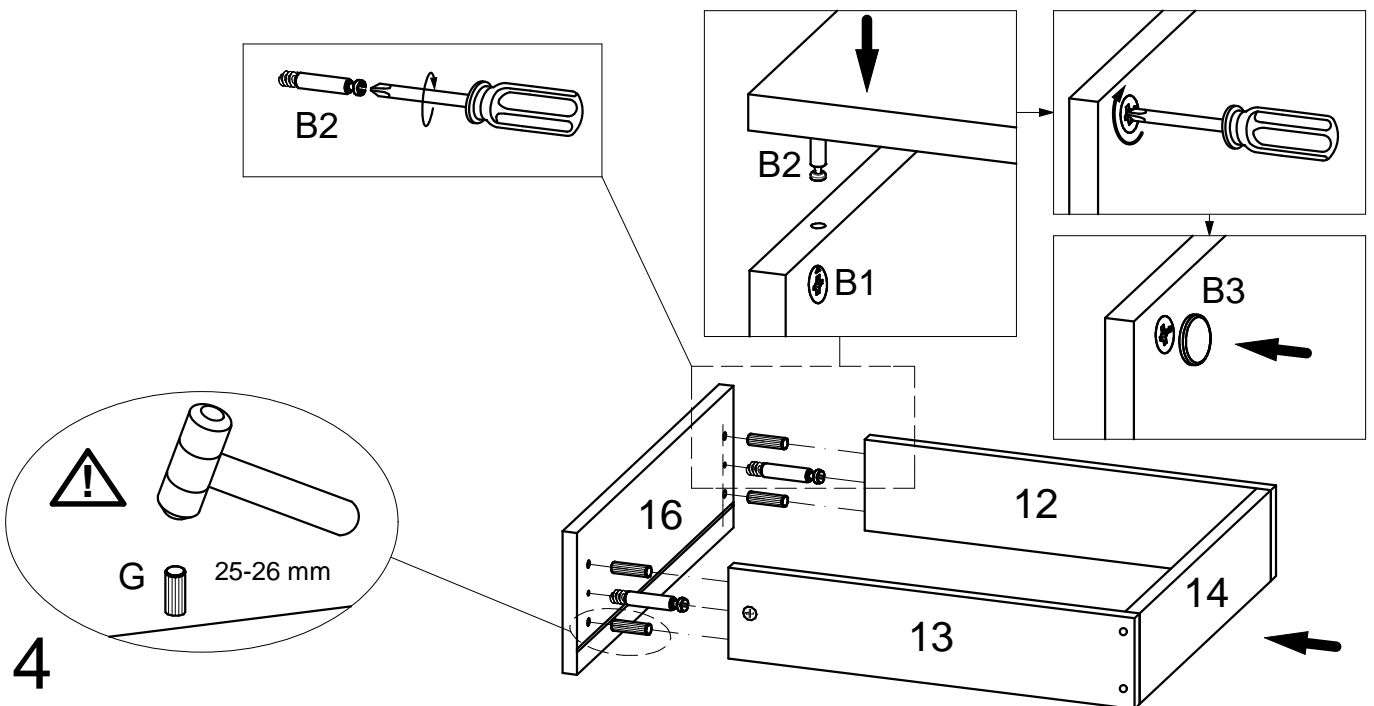
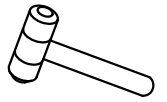
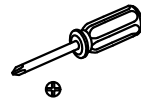

x 4

16

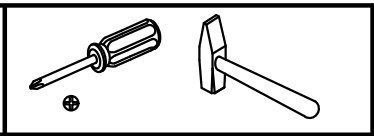
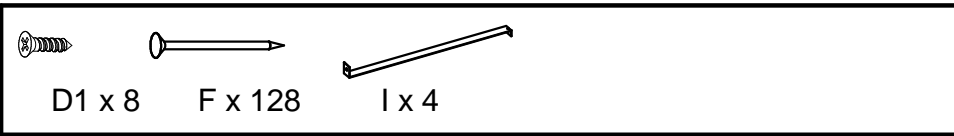

⚠ XX=YY≅90°

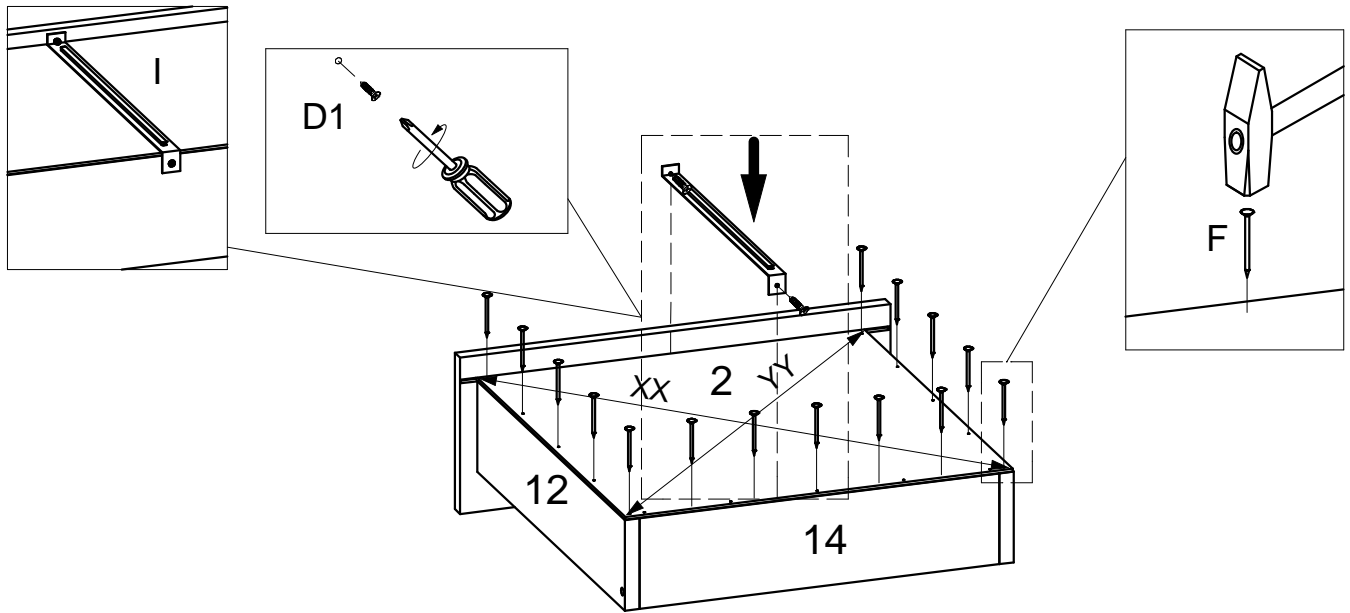

x 4

17

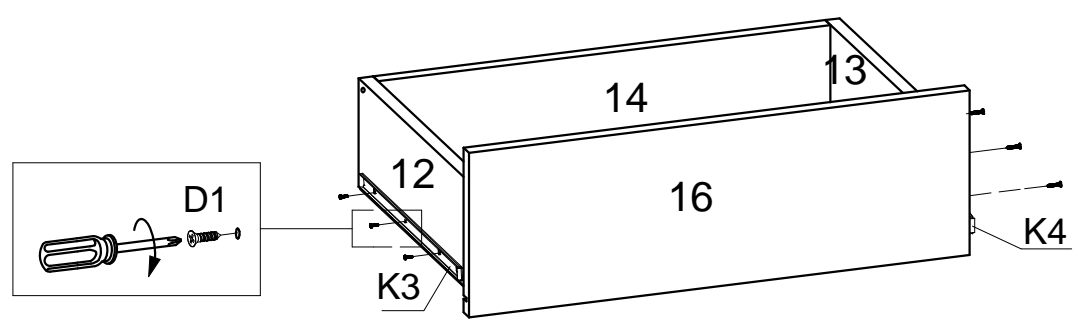
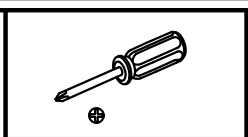
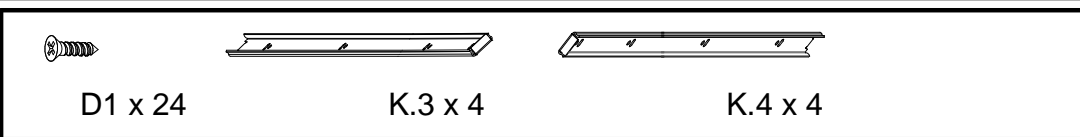

x 4

18



D1 x 4

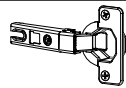

M.2 x 2

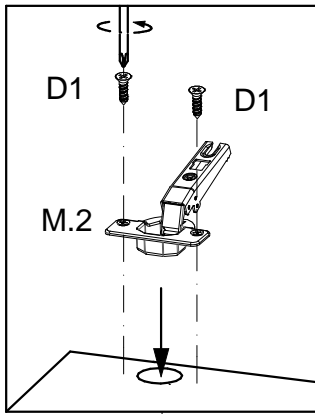
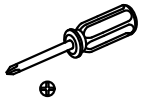

D1  
M.2

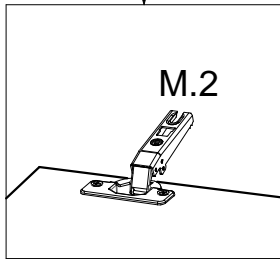

M.2

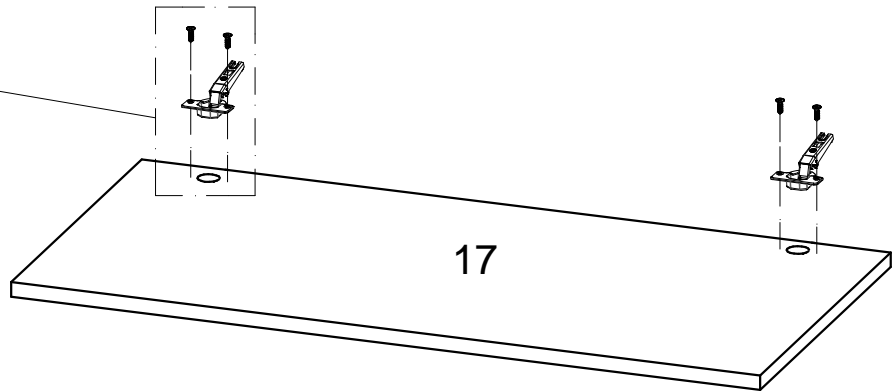

17

19

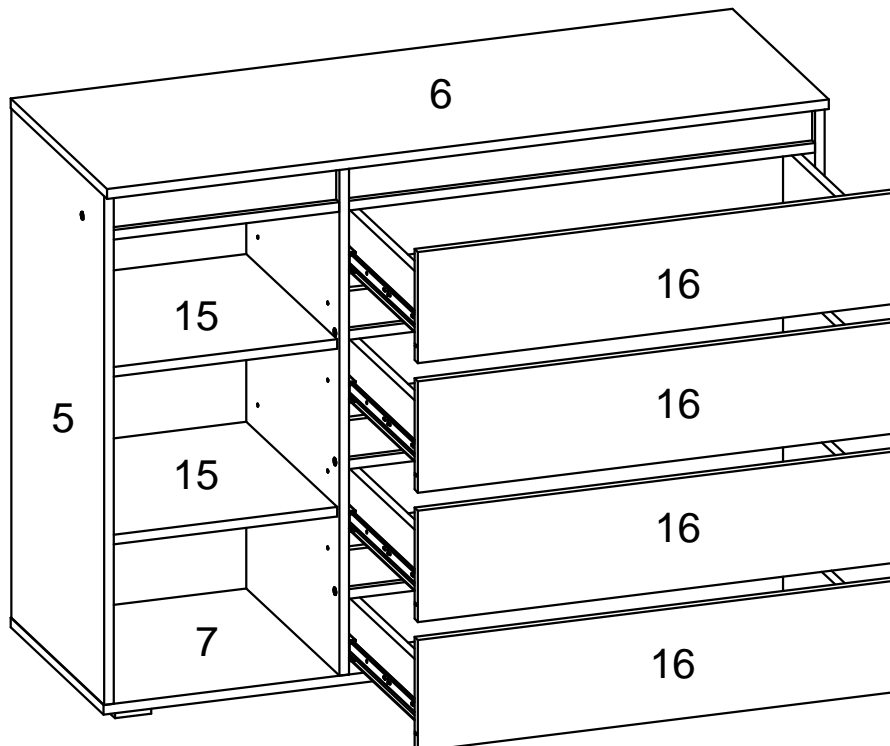



20

